

heliOptics™ / heliCam™

WLI5 / C3

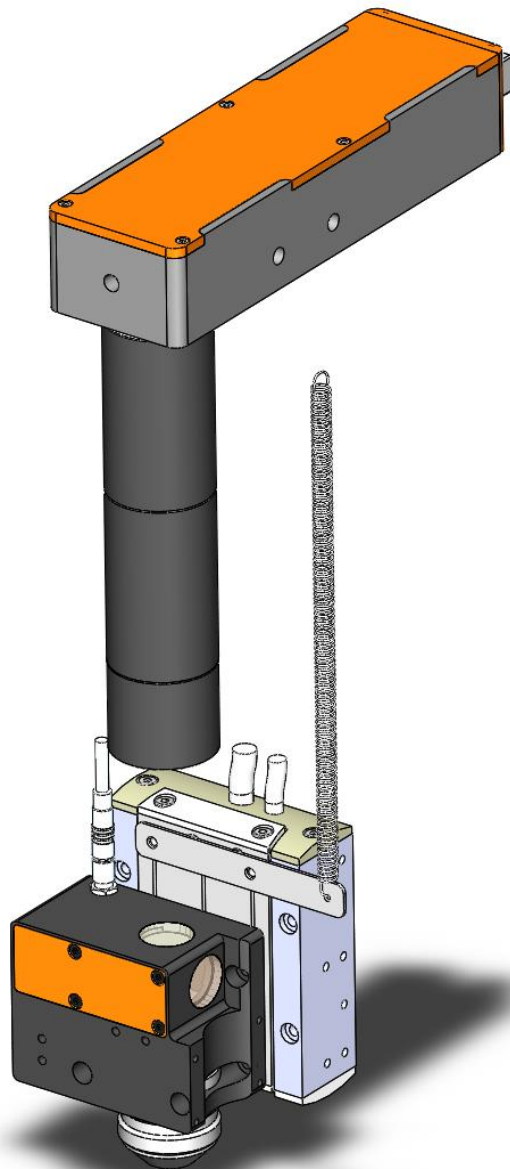

SYSTEMS GUIDE

# Table of Contents

(A) Configuration Options .....	3
1) heliOptics™ WLI5 – interferometer module .....	3
2) MIRAU objectives.....	4
3) WLI5 cover .....	5
4) heliOptics™ – lens tube.....	5
5) heliCam™ - high speed lock-in camera .....	6
6) Driver Electronics heliDriver™ D1 .....	6
7) Scanner .....	7
8) Axis Controller.....	8
9) Cabling.....	8
10) 2D-optics with LED lighting .....	10
11) Software.....	11
(B) Configuration Sheet.....	12

# (A) Configuration Options

## 1) heliOptics™ WLI5 – interferometer module

In concert with the high-speed camera C3, the interferometer module WLI5 allows for building custom white light interferometers. This modular kit is especially suited for integration into inspection machines with requiring high resolution.

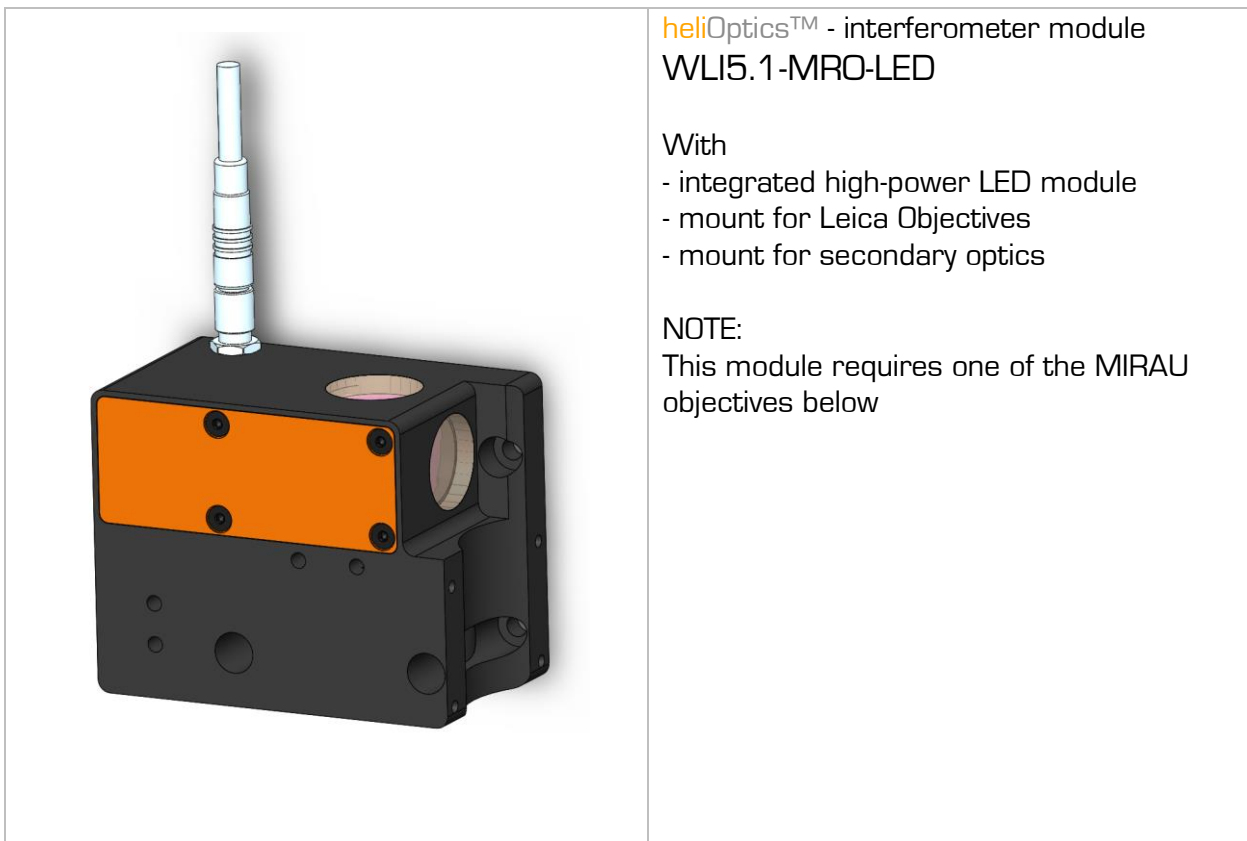

## 2) MIRAU objectives

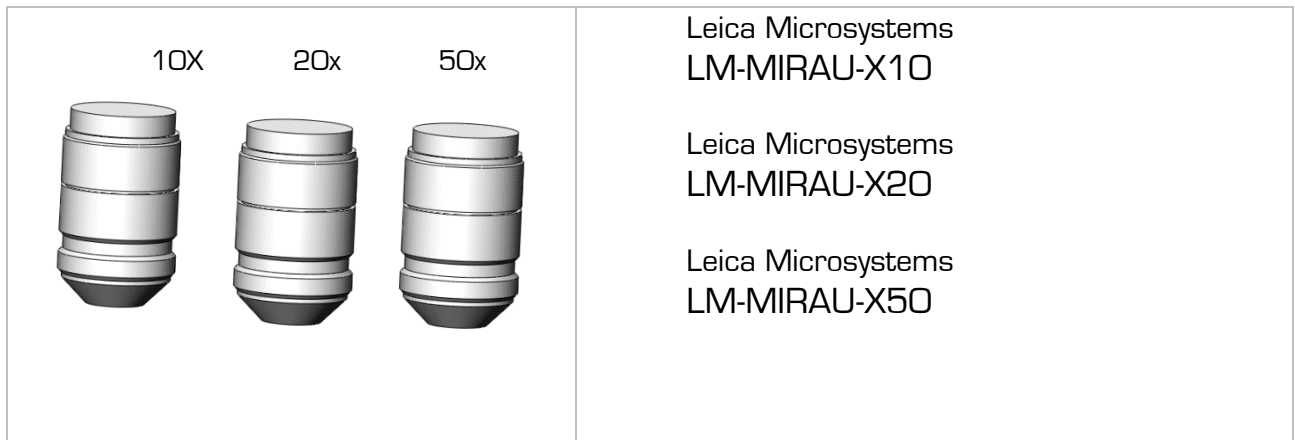

### Performance

WLI interferometer	Mirau configuration, exchangeable objectives (10x, 20x, 50x)		
light source	high power LED		
field of view (*)	232x222 $\mu\text{m}$	580x556 $\mu\text{m}$	1160x1112 $\mu\text{m}$
numerical aperture	0.5	0.4	0.3
working distance	2.52 mm	3.57 mm	3.57 mm
vertical resolution (*) (single meas., RMS)	50 nm 1 nm in phase mode	70 nm 1 nm in phase mode	100 nm 1 nm in phase mode
vertical scan speed (*)	up to 50 mm per second		
lateral resolution (*)	0.8 $\mu\text{m}$	2 $\mu\text{m}$	4 $\mu\text{m}$
reflectivity of sample (*)	< 0.1% to 100%		

(\*) with companion components heliCam™ C3 and high-precision scanner

### 3) WLI5 cover



### 4) heliOptics™ – lens tube



## 5) heliCam™ - high speed lock-in camera

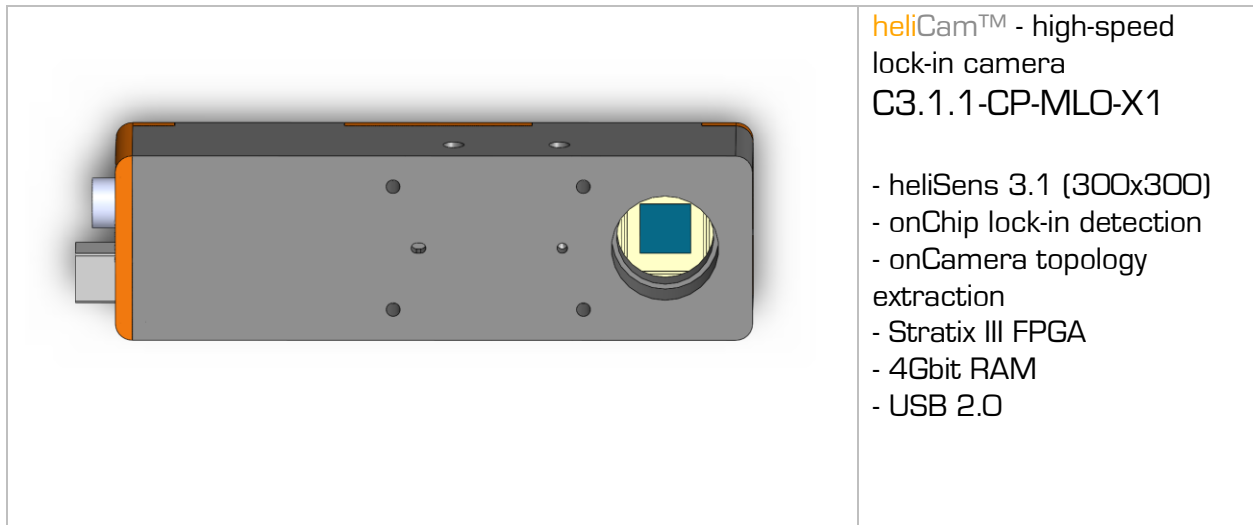

## 6) Driver Electronics heliDriver™ D1

The heliDriver™ supplies the C3 high-speed camera with power and serves to condition signals for trigger and position encoders. It can be configured to adapt to various input voltages and signal levels.

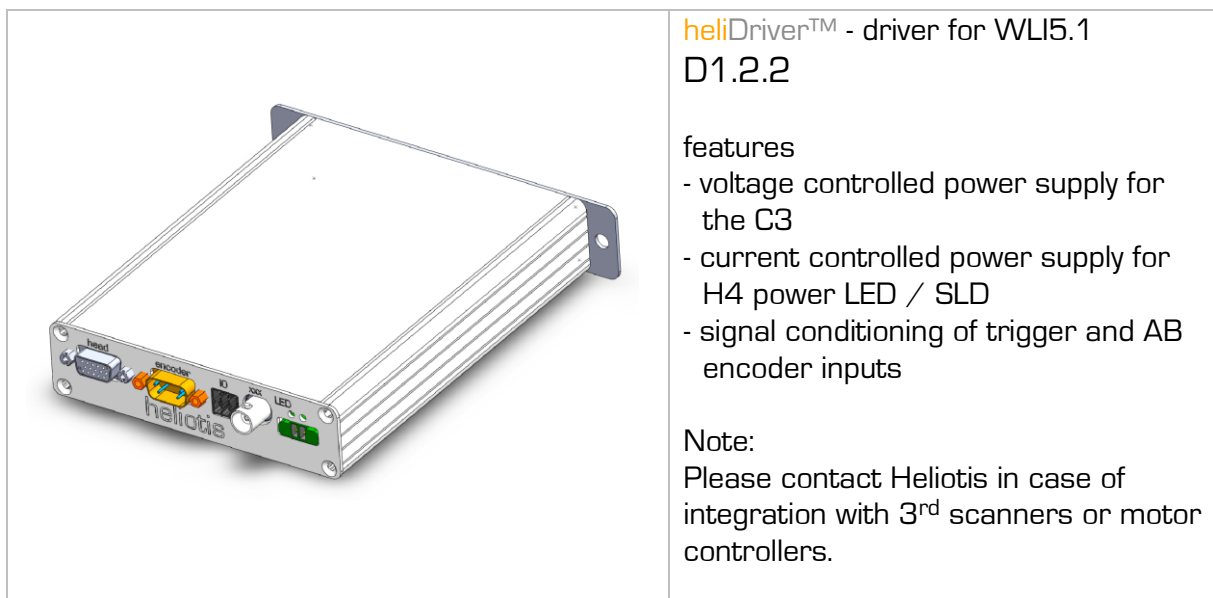

## 7) Scanner

The measurement principle (i.e. scanning white light interferometry) requires a precise axial movement. Heliotis recommends the following precision linear motor with integrated optical encoders. Its long and precise stroke accomplishes positioning and scanning operations in a single unit.

Note that the system performance may be optimized by selecting alternative scanners for a given application. Examples:

- For small height ranges (<500 micrometers) piezo based scanners may result in higher accuracy and shorter measurement times.
- For high accuracy applications scanners with higher resolution and tighter tolerances should be considered.
- Spindle motors with a high resolution measurement system may reduce system cost and complexity.

Please contact Heliotis in case alternative scanner stages should be used. Our engineers can recommend scanners and settings.

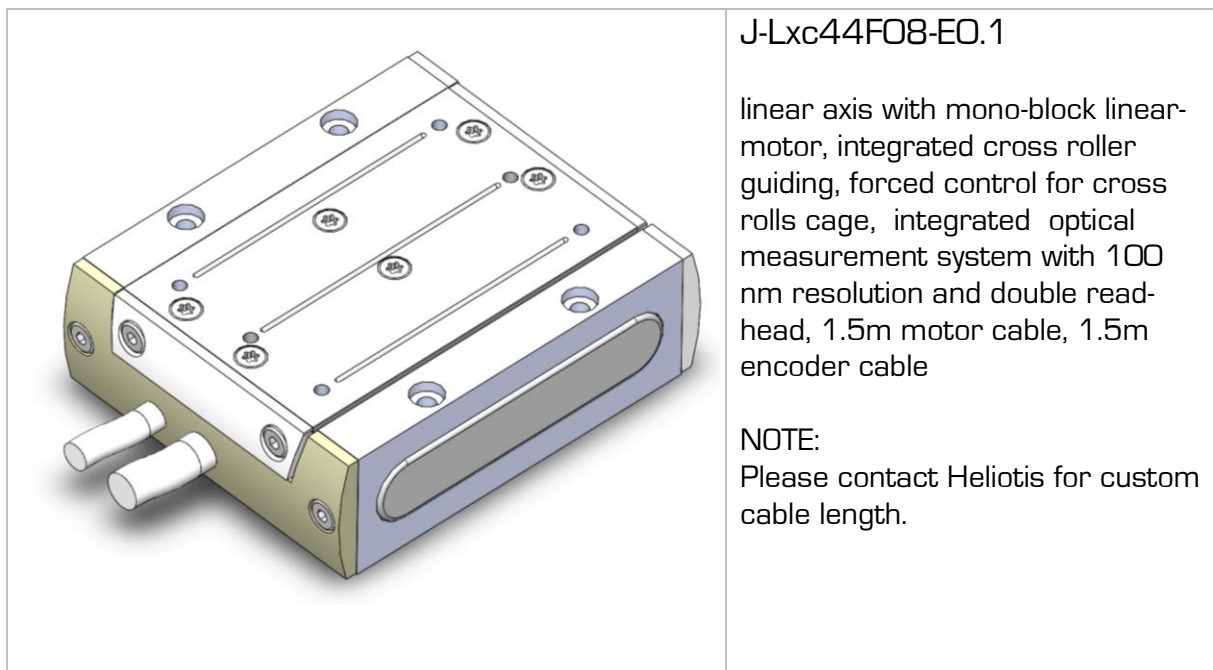

## 8) Axis Controller

To control the linear motors of the previous section, we recommend the servo controller below. This model is fully supported by the Heliotis' software development kit and software applications.

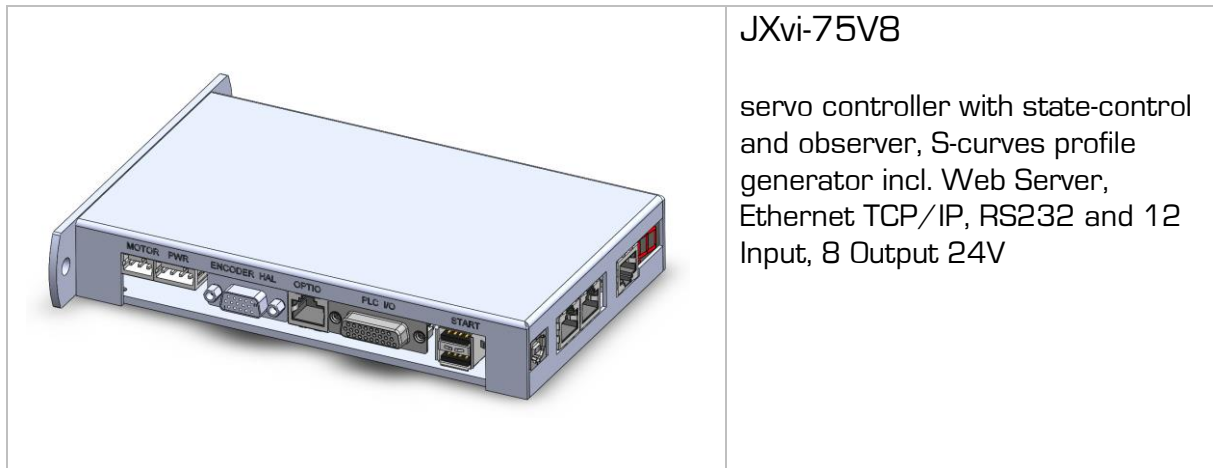

## 9) Cabling

The modular interferometer system should be wired as shown below. Cables come in standard length of 1.5 m, 3 m and 5 m. Please contact Heliotis in case of different length requirements.

For compatibility with drag chains the 'high-flex' cables should be chosen. Note that the 'trigger cable' comes with the **heliDriver™ D1** by default.



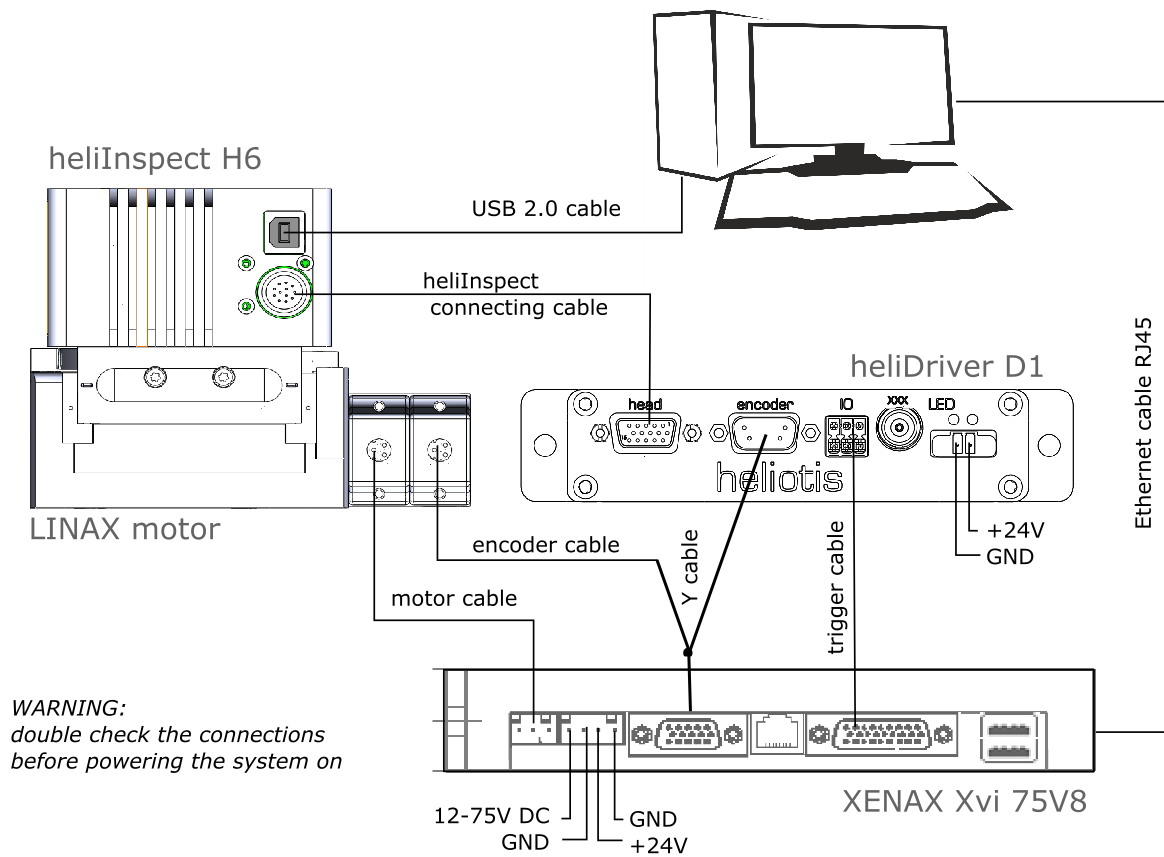

<p>connecting cable <b>heliInspect™</b></p> <p>HD D-Sub 15P Male --12x0.14mm2-- Hirose HR10-10P-12PA</p>	<p>standard cable</p> <p>HI-CC-L1.5-ST (length 1.5m) HI-CC-L3.0-ST (length 3.0m) HI-CC-L5.0-ST (length 5.0m)</p> <p>chain-flex cable</p> <p>HI-CC-L1.5-CF (length 1.5m) HI-CC-L3.0-CF (length 3.0m) HI-CC-L5.0-CF (length 5.0m)</p>
<p>motor cable</p> <p>motor pigtail - Wago 3.5mm</p>	<p>- comes with Lxc motor (pigtail)</p> <p>- standard length is 1.5m</p> <p>Please contact Heliotis for custom length.</p>

encoder cable  motor pigtail - HD D-Sub 15 pole pins	- comes with Lxc motor (pigtail)  - standard length is 1.5m  Please contact Heliotis for custom length.
Y-cable for XENAX encoder  1 x 15 pole HD D-Sub male, 1 x 15 pole HD D-Sub female, 1 x D-Sub 9 x pole female, length 0.25m	F-Y-CABLE-D-SUB-LO.5
USB cable, length = 4.5m high-flexibility, 10 million cycles, compatible with drag chains	X-USB-L4.5-CF
GigE cable length = 5m	X-RJ45-L5-5E

## 10) 2D-optics with LED lighting

For applications which require 2D live view, high-resolution 2D images or color images, the WLI5 can be equipped with a 2D-module. The module consists of a high-resolution objective, LED illumination and mounting parts.

The objective is mounted in reverse, which means that the acquiring camera needs to be equipped with a second objective tuned to infinite. Please contact Heliotis for detailed information.

	<p><b>heliOptics™ - 2D optics with LED lighting WLI5.1-2D-LED</b></p> <ul style="list-style-type: none"> <li>- mount compatible with WLI5.1 modules</li> <li>- includes a 50mm fixed objective with Locking Iris/focus for 2/3-Inch CCD, f/1.4 to f/22, reverse mount</li> <li>- 24V LED direct lighting</li> <li>- 24V LED side illumination with 8 sections</li> </ul>
---	--

# 11) Software

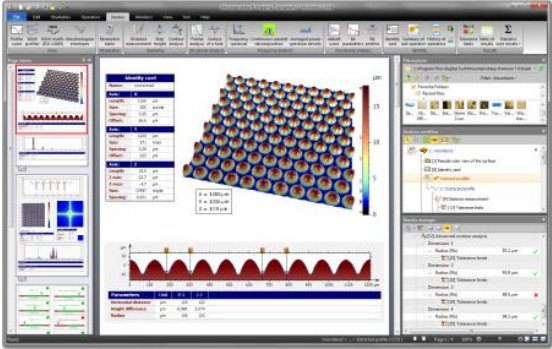
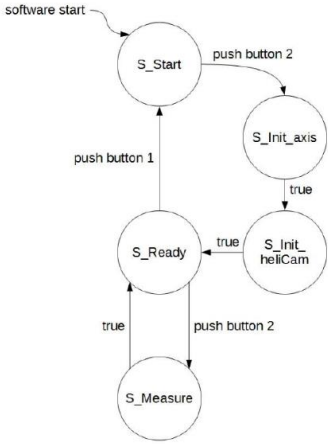
	<p><b>heliCommander™ 3.3</b> <b>PX-HC3.3</b></p> <p>Graphical User Interface and application framework supporting</p> <ul style="list-style-type: none"> <li>- 3 axis portal</li> <li>- heliInspect™ 3D-sensors</li> <li>- 2D-camera module</li> <li>- interactive operation</li> <li>- automated operation (recipes)</li> <li>- TCP/IP socket interface</li> </ul>
	<p><b>MountainsMap™</b> <b>Imaging Topography</b> <b>DS-MM-TOPO</b></p> <ul style="list-style-type: none"> <li>- comprehensive report generation</li> <li>- large number of operators, e.g. surface parameters ISO 25178 and ISO 4287</li> <li>- WYSIWYG report editor</li> </ul>
 <pre> stateDiagram-v2     [*] --&gt; S_Start : software start     S_Start --&gt; S_Init_axis : push button 2     S_Init_axis --&gt; S_Init_heliCam : true     S_Init_heliCam --&gt; S_Ready : true     S_Ready --&gt; S_Start : push button 1     S_Ready --&gt; S_Measure : push button 2     S_Measure --&gt; S_Ready : true     </pre>	<p><b>Software Development Kit</b> <b>heliSDK1.6</b></p> <ul style="list-style-type: none"> <li>- for integration into client applications based on C++, LabVIEW®, Halcon™ or Python</li> <li>- available on Windows and Linux</li> <li>- free of charge</li> </ul>

# (B) Configuration Sheet

Function	Configuration	Selection
<b>Interferometer module</b>	WLI5.1-MRO-LED 60 03 10	x
<b>Mirau objectives</b>	LM-MIRAU-X10 90 02 10	
	LM-MIRAU-X20 90 02 20	
	LM-MIRAU-X50 90 02 50	
<b>Cover</b>	WLI5.1-COVER 60 03 20	
<b>Lens tube</b>	TB2.0-VIS 60 00 02	
<b>Lock-in camera</b>	C3.1.1-CP-MLO-X1 30 03 02	x
<b>Driver electronics</b>	D1.2.2 40 00 01	x
<b>Scanner</b>	J-Lxc44F608-EO.1 90 01 00	
<b>Axis controller</b>	J-Xvi-75V8 90 01 15	
<b>Connecting cable</b>	HI-CC-L1.5-ST 40 03 65	
	HI-CC-L3.0-ST 40 03 66	
	HI-CC-L5.0-ST 40 03 67	
	HI-CC-L1.5-CF 40 03 60	
	HI-CC-L3.0-CF 40 03 61	
	HI-CC-L5.0-CF 40 03 62	
<b>Motor cable</b>	- comes with the scanner (pigtail)  - please specify required length	
<b>Encoder cable</b>	- comes with the scanner (pigtail)  - please specify required length	
<b>Y-cable</b>	F-Y-CABLE-D-SUB-LO.5 90 01 50	

<b>USB cable</b>	X-USB-L4.5-CF 90 00 00	
<b>GigE cable</b>	X-RJ45-L5-5E 90 00 10	
<b>2D-optics module (optional)</b>	WLI5.1-2D-LED 60 03 11	
<b>Software</b>	heliCommander3.3 50 90 20	
	heliViewer3.2 50 90 10	X (free)
	heliSDK1.6 50 90 00	X (free)
	DS-MM-TOPO 90 04 00	